



Free Standing Work Station Bridge Cranes

Ceiling Mounted Work Station Bridge Cranes

Aluminum Work Station Bridge Cranes

ERGONOMIC WORK STATION CRANES

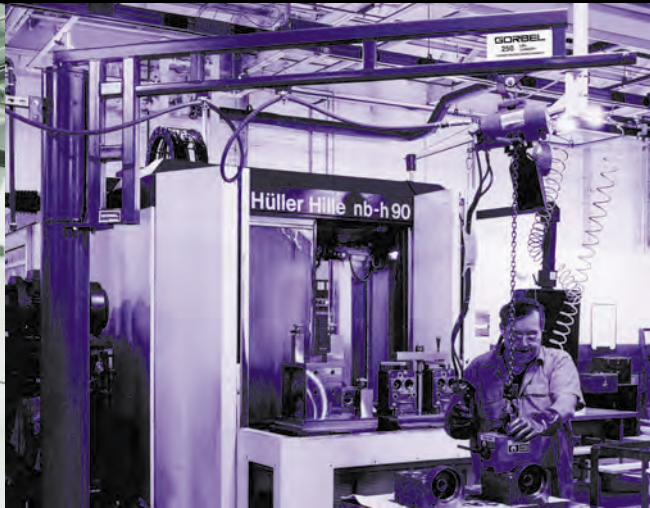

Work Station Jib Cranes

I-Beam Jib Cranes

Articulating Jib Cranes

Aluminum Work Station Jib Cranes



Seismic Zone IV Earthquake Resistant Cranes

Automated Cranes

G-Force™ Intelligent Lifting Device

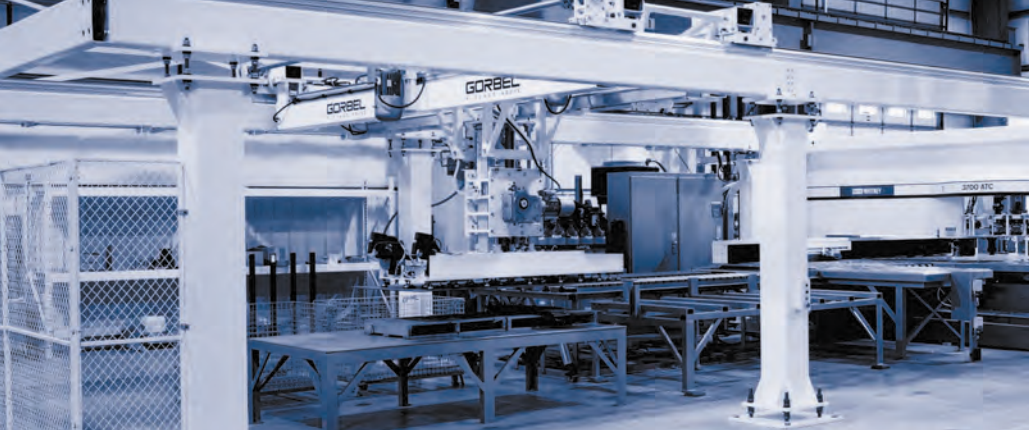

Gantry Cranes

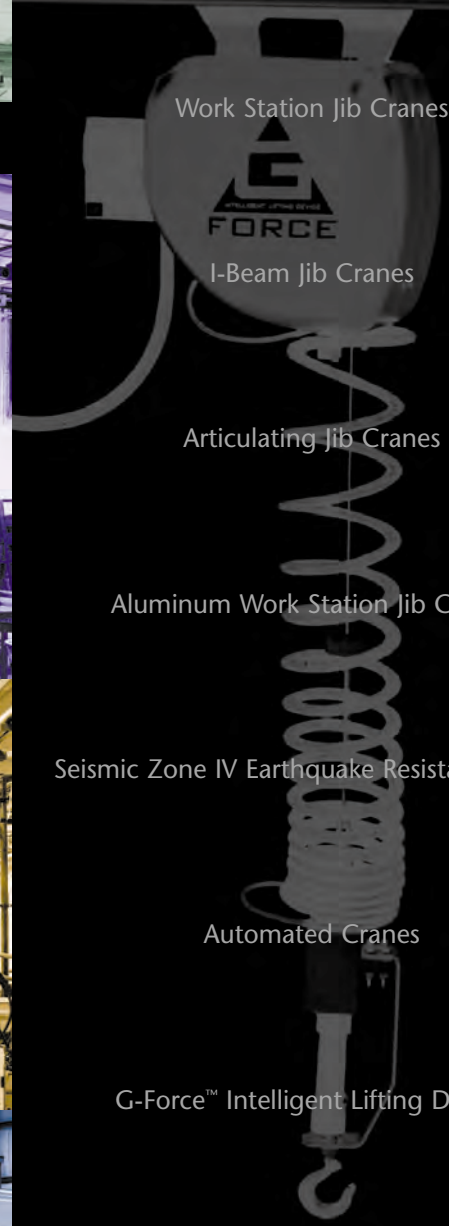

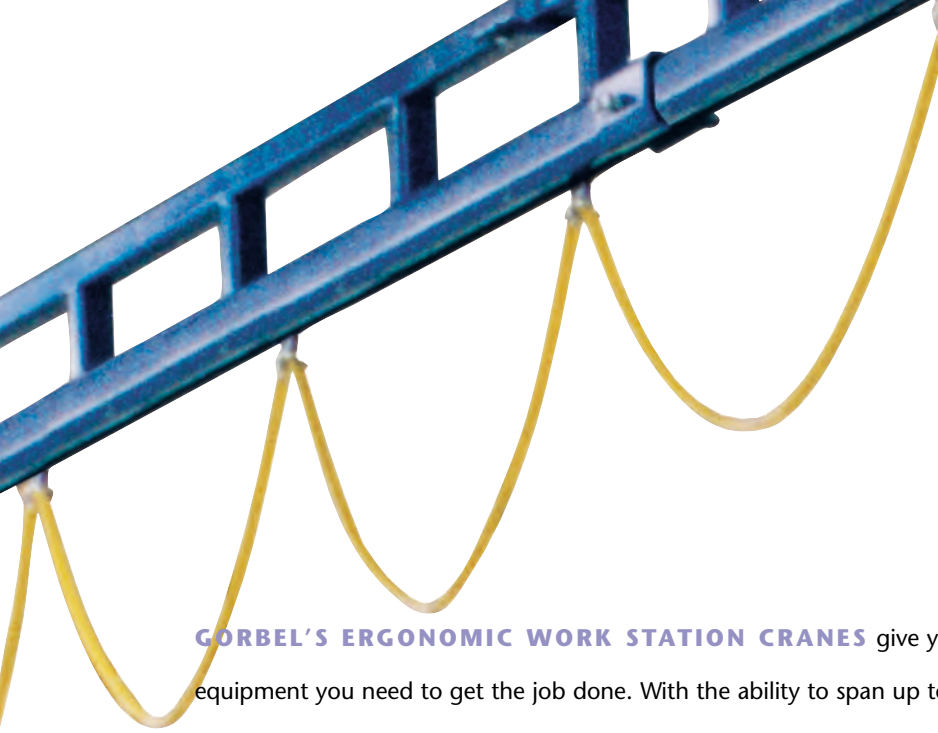

GORBEL'S ERGONOMIC WORK STATION CRANES give you the handling equipment you need to get the job done. With the ability to span up to 30 ft. and lift capacities between 150 and 4000 lbs., our line of Ergonomic Work Station Crane products guarantees increased productivity. Depending on your needs, Gorbel has the Work Station Cranes that are sure to handle any project.

SAFE, PRODUCTIVE ERGONOMIC SOLUTIONS

Since 1977, Gorbel has been an innovator and leader of lifting loads in a work cell. Gorbel began as a manufacturer of manually or power operated Jib Cranes, including wall bracket, wall cantilever, free standing, and mast type models. In 1986, Gorbel added a line of Work Station Cranes, which addressed the trend for safe, productive, ergonomic solutions for overhead material handling operations. Another product addition for Gorbel came in late 1997, when we began manufacturing a line of Automated Work Station Cranes. These cranes automatically move and position products up to 4000 lbs. at speeds up to 120 ft. per minute, with an accuracy level of 1/4" to 3/8". In the new millennium, Gorbel introduced the G-Force™ Intelligent Lifting Device. The G-Force™ allows workers to lift objects up to 600 lbs. at high speeds with little effort. All Gorbel products are manufactured at state-of-the-art facilities in New York and Alabama and are sold through an extensive dealer network.

Today, Gorbel is continuing to increase quality and customer service standards to exceed our customers' positive expectations. Gorbel takes pride in on-time, error-free shipments as well as the industry's best product warranty—5 years on most products.

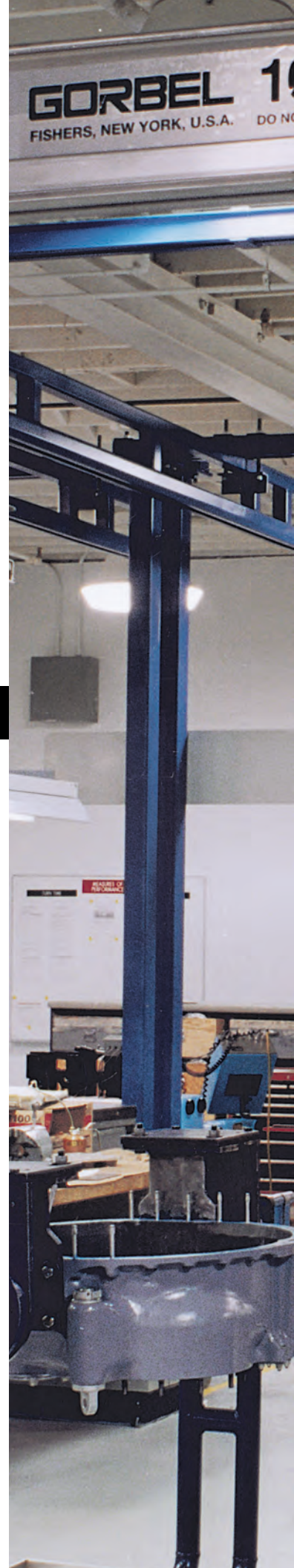

000 LBS.
CAPACITY
DO NOT EXCEED RATED CAPACITY

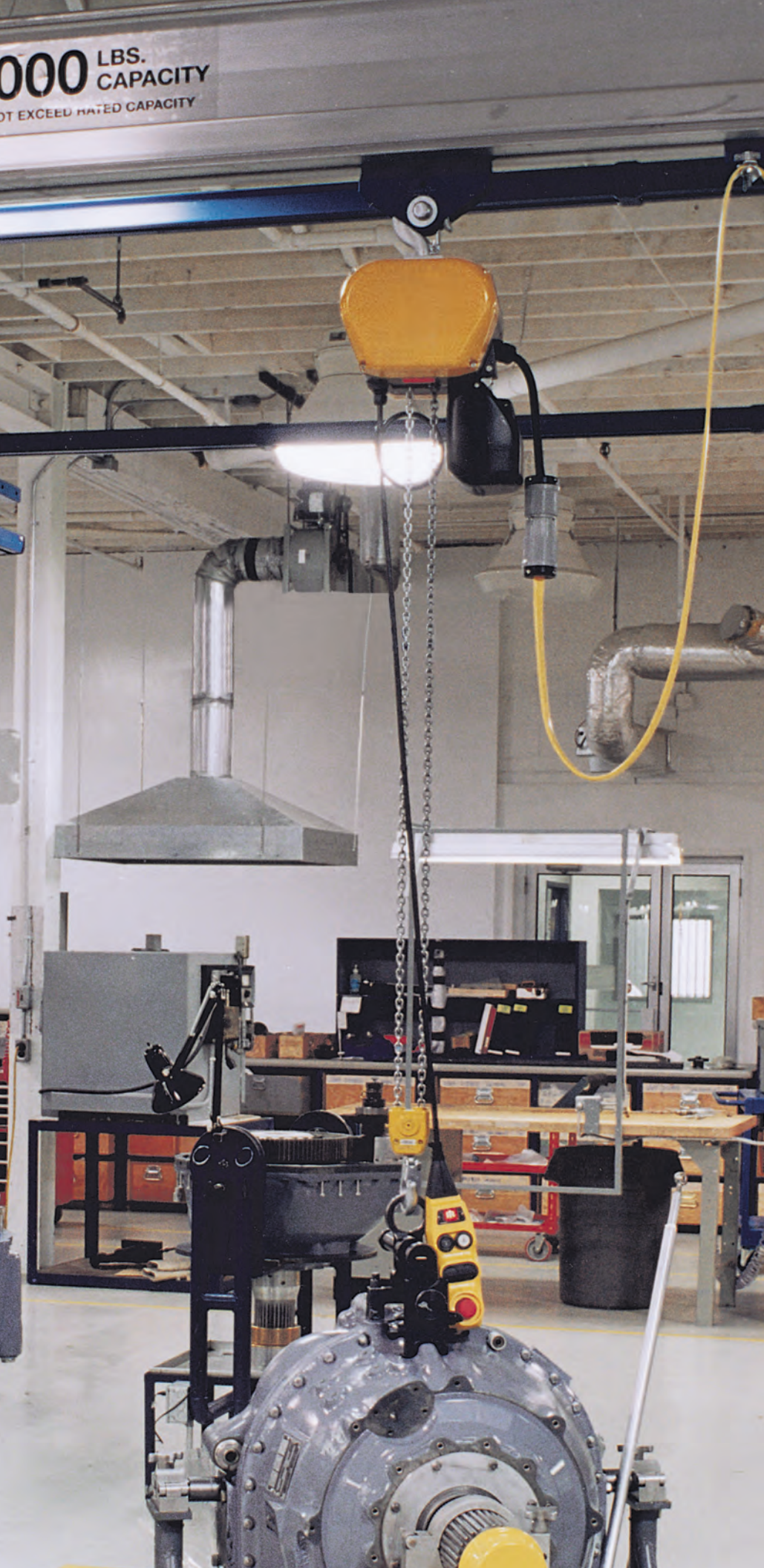

NINE REASONS WHY YOU SHOULD CHOOSE GORBEL WORK STATION CRANES

- 1 Industry's Best Warranty—
5 years on most products
- 2 "If it's late, we pay the freight"
- 3 5-Day Quick Ship, 2- or 3-Day
Quick Ship (premium service)
- 4 Ease of Installation
- 5 Ease of Positioning
- 6 Designs, Spans and Capacities
- 7 Productivity
- 8 Reliability
- 9 Increased Safety

Ask an authorized Gorbel dealer
for more details on any of the
above programs.

GORBEL
A CLASS ABOVE



FREE STANDING WORK STATION BRIDGE CRANES

Gorbel Free Standing Work Station Bridge Cranes can handle the toughest overhead lifting tasks. These cranes, which can be installed on any normal 6-inch reinforced concrete floor, feature a pre-engineered modular design that can easily expand as your work centers expand.

FEATURES:

- Designed to be completely free standing and do not require sway bracing
- Ease of installation
- Easy movement
- Superior load positioning
- Capacities from 250 to 4000 lbs.
- Bridge lengths from 4 ft. to 34 ft.
- A modular design for flexible factory layouts
- Multiple bridges can be installed on one runway system to increase productivity and flexibility in a work area

CANTILEVERED SUPPORT COLUMNS

Increasing the effectiveness of large cranes, these support columns are used where material is delivered or removed from work cells by large overhead cranes or in applications where doors swing into the area.

Cantilevered supports can handle loads up to 4000 lbs. and are the answer anytime the normal header of a free standing support assembly interferes with an operator's activity in the work cell.

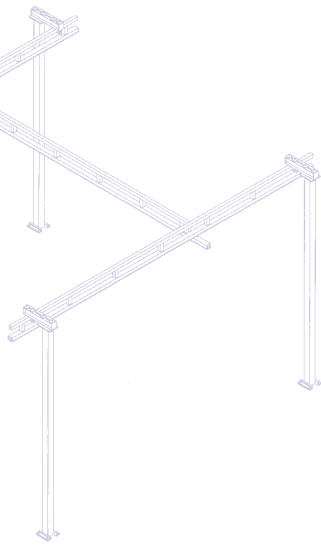

SEISMIC ZONE IV EARTHQUAKE RESISTANT CRANES

Designed for Seismic Zone IV, this crane can handle loads up to 4000 lbs. Gorbels Seismic Zone IV Free Standing Work Station Cranes have been designed for the most rigorous applications in areas that must adhere to Seismic Zone IV building code requirements.

FEATURES:

- Spans up to 30 ft.
- Free Standing or Ceiling Mounted
- Easy movement for increased productivity
- Steel and aluminum enclosed track designed to be completely free standing and does not require sway bracing



ALUMINUM WORK STATION BRIDGE CRANES

For demanding, rapid, repetitive handling applications, the Aluminum Work Station Bridge Crane is the best ergonomic solution on the market. It is also ideal for facilities with structural limitations and challenging environments. This crane reduces bridge dead weight by up to 40%. And our unique aluminum design, using high strength aluminum alloy, results in an unparalleled combination of spans, capacities, lightweights and ease of movement.

FEATURES:

- A modular design that lets you use aluminum bridges on steel runways to provide cost effective solutions that are easy to install, expand and field customize
- A unique track design that facilitates installation and provides precise track alignment (patent pending)
- Up to 40% lighter in weight than equivalent steel track systems
- Special anti-binding end trucks for free and easy movement

GORBEL
A CLASS ABOVE



CEILING MOUNTED WORK STATION BRIDGE CRANES

When a work area must be free from any support structures that may interfere with operations, ceiling mounted bridge cranes are an excellent solution to keeping floors clear. Handling capacities up to 4000 lbs. with overall bridge lengths up to 34 ft., these systems are pre-engineered and modularly designed for easy installation, expansion and relocation. Customers can install multiple bridges along one set of runways and greatly increase their productivity.

FEATURES:

- Ease of installation
- Effortless movement
- Superior load positioning
- Capacities from 250 to 4000 lbs.
- Bridge lengths from 4 ft. to 34 ft.
- A modular design for flexible factory layouts
- Multiple bridges can be installed on one runway system to increase productivity and flexibility in a work area

NESTED TROLLEY

Ideal for low headroom applications, our nested trolleys enable you to raise the height of the hoist and increase the available lift. A nested trolley is constructed of a dual girder bridge with a box shaped assembly (a "nest") that travels between the bridge girders. With this custom designed "nest", the hoist is mounted up inside the bridge structure, which allows you to get back the lift typically taken up by the body of the hoist.



OPTIONS FOR CEILING MOUNTED OR FREE STANDING CRANES

MANIPULATOR PLATFORMS

Gorbel's manipulator platforms are specially designed platforms to support almost any rigid or base plate mounted lifting devices and manipulators. With this type of crane, one manipulator can be used in multiple work cells or be moved anywhere within the crane coverage area. Features include leveling capabilities to prevent unwanted drifting, and anti-kickup trolleys and end trucks to prevent binding.



INTERLOCK/TRANSFERS

Gorbel's interlock/transfer cranes allow loads to be transferred from a bridge crane to monorail spurs and vice-a-versa. The interlock/transfer cranes are fast and easy to use. The bridge only engages the interlock when the operator actuates it so they do not impede the workers when not in use. The interlock is designed so the trolley stops will lock and not allow the passage of the hoist trolley until the bridge and monorail are in alignment and mechanically linked. The bridge and monorail spur cannot be separated until the trolley stops are fully closed and in the locked position. They can be easily adapted to an existing Gorbel Work Station Bridge Crane.



TELESCOPING BRIDGES

Gorbel's telescoping bridge crane allows for extension outside the normal reach of a Gorbel Work Station Bridge Crane. The telescoping bridge is designed for effortless movement and easy installation. The bridge features an adjustable leveling device and anti-kickup wheels to prevent binding of the bridge when telescoped. Applications for a telescoping bridge include reaching into adjacent work cells to transfer material, loading parts into a machine opening, and reaching out beyond a building column or under mezzanines.



TRACTOR DRIVES FOR STEEL AND ALUMINUM TRACK

Gorbel's tractor drives provide motorized movement on new or existing enclosed track Gorbel Work Station Bridge Cranes and Monorails. The drives are designed for indoor use and are available for steel track or aluminum track. Applications for tractor drives include work areas where the operator cannot stand next to the load to move it by hand or during operations with high cycle times that require frequent lifting of heavy, awkwardly shaped loads.



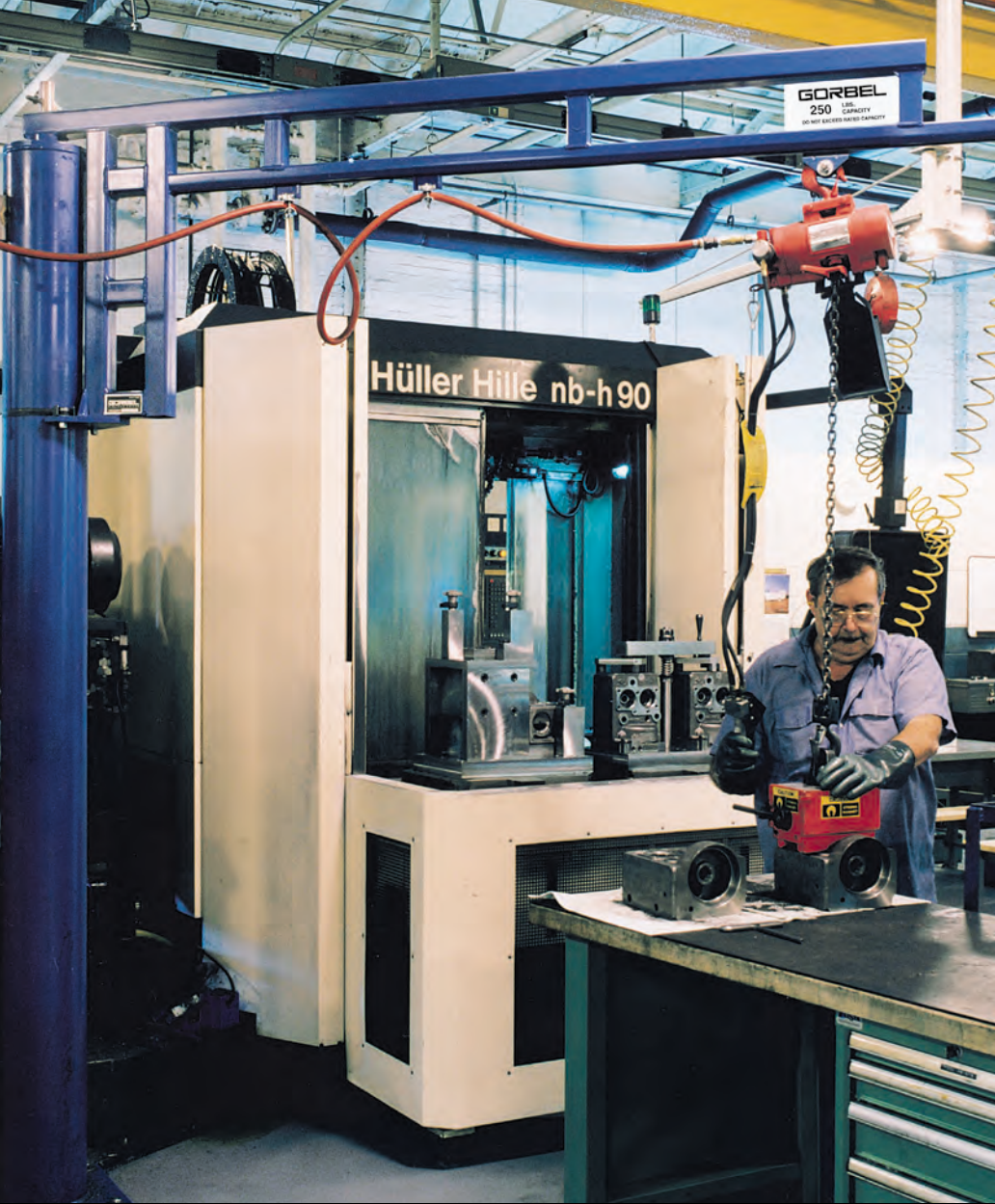

WORK STATION JIB CRANES

Work Station Jib Cranes are the ideal substitute for traditional, heavy I-Beam jib cranes. These jibs are designed to service circular areas and support tool balancers, air balancers, vacuum lifters and hoists. When column or wall mounted, they can handle up to a 200° rotation. When floor mounted, they can accommodate up to a 360° rotation. Capacities are available from 100 lbs. to 1000 lbs. with spans up to 16 ft.

FEATURES:

- Tapered roller pivot bearings and trunnion rollers for ease of rotation
- Enclosed track boom that virtually eliminates dirt and dust
- High-strength, lightweight, low-headroom boom assemblies
- Many of the smaller, lighter capacity jibs can be mounted on any normal 6" reinforced concrete floor (no foundation required; contact the Factory for details)
- Enclosed track boom provides effortless trolley movement and virtually eliminates dust and dirt

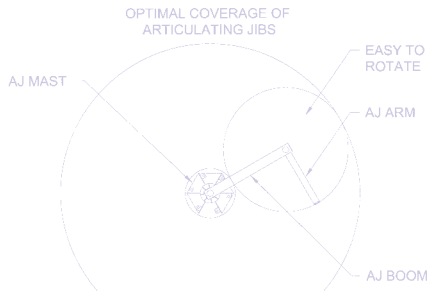

ARTICULATING JIB CRANES

This versatile crane can move loads around corners, reach into machines or doorways, and swing under obstructions. This crane is also perfect in applications that require an operator to rotate the jib in close to its pivot point. Capacities from 150 lbs. to 2000 lbs. with spans up to 16 ft. Available in free standing, ceiling and wall mounted.

AL100 WALL BRACKET WORK STATION JIB CRANES 200° ROTATION

The AL100 Wall Bracket Work Station Jib Crane utilizes Gorbel's patented light-weight, high-strength extruded aluminum enclosed track. This revolutionary track reduces the rotational dead weight of the boom by 56% to 68%, making the jib up to 40% easier to rotate than comparable I-beam jibs. The tie rod design minimizes deflection and is more precise when positioning loads than other jibs.

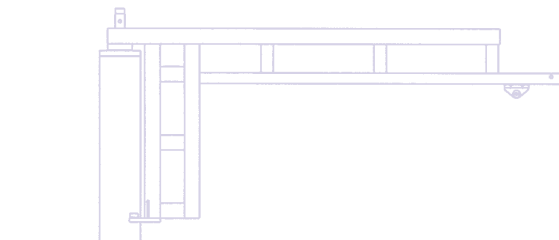

PORTABLE BASES

The portable bases allow jibs to be picked up with a fork truck and moved anywhere in a facility. They are available in capacities up to 1000 lbs. and spans up to 16 ft.

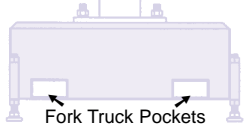

I-BEAM JIBS

Gorbel's I-Beam Jibs are available in free standing, wall bracket, wall cantilever and mast-type jibs. They are ideal for heavier loads from 1 to 5 tons (heavier capacities available, contact the Factory). They are also available in motorized or manual rotation.

FREE STANDING JIB CRANES (FS300, 350, 350S)

- Floor-mounted or insert style
- Capacities from 1/4 ton to 5 tons, with heights and spans up to 20 ft. Contact the Factory for additional heights, spans and capacities
- Versatile cranes well-suited for use beneath traveling cranes, in open areas where they serve several work areas, in outdoor applications, and in machining and assembly operations



PERFORMANCE I-BEAM JIB CRANES

WALL CANTILEVER JIB CRANES (WC200)

- Used instead of a wall bracket jib crane when headroom is at a premium
- Provides hoist coverage for individual use in bays, along walls or columns, and as supplements to an overhead crane or monorail system
- Capacities from 1/4 ton to 5 tons, with spans up to 20 ft. Contact the Factory for additional spans and capacities
- Requires a structurally adequate wall or column to support the jib



WALL BRACKET JIB CRANES (WB100)

- Economically provides hoist coverage for individual use in bays, along walls or columns, or as supplements to an overhead crane or monorail system
- Capacities from 1/4 ton to 5 tons, with spans up to 30 ft. Contact the Factory for additional heights, spans and capacities
- Requires a structurally adequate wall or column to support the jib
- Requires sufficient clearance above the boom throughout its arc to accommodate the tie rod suspension



MAST-TYPE JIB (MT400, 450)

- Typically do not require special foundations
- Floor-supported, top-stabilized cranes capable of 360° rotation via a top and bottom bearing assembly
- Provides for dramatically reduced forces to supporting structures
- Capacities from 1/4 ton to 5 tons, with heights up to 20 ft. and spans up to 20 ft. Contact the Factory for additional spans and capacities
- Full Cantilever and Drop Cantilever styles





THE SMARTER WAY TO LIFT

THE G-FORCE™ BXi and BX INTELLIGENT LIFTING DEVICES

The G-Force™ is a servo-powered lifting device that enables operators to lift loads and manipulate objects like it is an extension of their own arm. It uses exclusive patented technology and an industrial processor-controlled servo drive system to deliver unmatched lifting precision and speed. Its fusion of advanced technology and basic human guidance maximizes productivity while minimizing the risk of injury to the operator.

PINPOINT PRECISION

The G-Force™ delivers unparalleled precision at speeds from less than 1 fpm up to 275 fpm, giving operators the control necessary to finesse expensive or fragile parts.

BLAZING SPEEDS

With speeds reaching 275 fpm, the G-Force™ travels up to 4 times faster than traditional high end lifting devices currently on the market.

INFINITE SPEED CONTROL

The G-Force™ moves as fast or as slow as the operator chooses to move. It is ideal for applications that require high speed at some points in the cycle and slow, precise movements at other points.

The G-Force™ now comes in two series, the BXi and BX, to better match your application and budget. The BXi and BX are both available in standard capacities of 150 and 300 lbs. Both series come with standard safety features, including Anti-Recoil, Capacity Overload Protection, Power Loss Protection, Operator Present Switch, E-Stop Button and Operator Indicator Lights.

G-FORCE™ BXi SERIES:

Our highest performance G-Force™, the BXi model, comes loaded with standard intelligence features and programmability to customize it to your application.

G-FORCE™ BX SERIES:

Our streamlined G-Force™ BX model has virtually identical performance characteristics to the BXi model in terms of speed, pinpoint precision and intuitive control. It is a lower cost alternative for those applications that require the speed and precision of the BXi, but not the added intelligence capabilities.

For in depth specifics on the technical features and intelligence capabilities, visit www.gorbel.com/gforce.





AUTOMATED CRANE SYSTEMS

AUTOMATED CRANE SYSTEMS

The Automated Crane System is ideal for applications where a fully robotic system is just too complex or too costly. Use this system for operator initiated applications that require speeds up to 120 fpm and positional accuracy from 1/4" to 3/8".

Gorbel's Automated Crane can be used in a variety of industrial environments. Our long spanning, pre-engineered systems can provide coverage of multiple work cells with several pick and place locations over a 34' X 100' area.

POTENTIAL APPLICATIONS:

- Assembly line product handling
- Dip tank operations
- Handling fragile, sensitive material
- Sheet steel handling
- Palletizing operations

GORBEL
A CLASS ABOVE

FOR MORE INFORMATION

Your authorized Gorbel dealer can give you more information on what makes Gorbel's Ergonomic Work Station Cranes and other Gorbel products "A Class Above." Publications that are available include:

BRIDGE CRANES

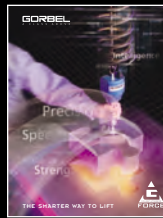

G-Force™



Automated



Free Standing



Ceiling Mounted

JIB CRANES



Jib & Gantry Cranes



Work Station



Articulating

SPECIALTY PRODUCTS



Seismic Zone IV



Telescoping



Tractor Drives



Interlock/Transfer

ERGONOMIC STUDIES

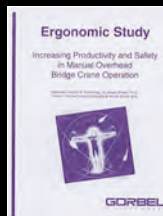

Productivity & Safety

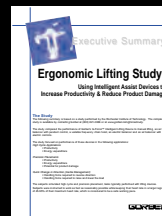

G-Force™ Study



Gorbel Inc.
600 Fishers Run, P.O. Box 593
Fishers, NY 14453-0593
Phone: 800-821-0086
Fax: 800-828-1808
E-mail: info@gorbel.com

www.gorbel.com