

GORBEL®

A C L A S S A B O V E



Overhead solutions for every application

GORBEL[®]
A CLASS ABOVE

A Class Above

Since 1977, Gorbel has been providing overhead material handling equipment solutions that are A Class Above in quality, reliability, performance and safety. Assembled exclusively in the U.S.A., Gorbel cranes are being used in dozens of industrial applications all over the world. We've also expanded our ownership of the overhead universe with a full line of engineered and mobile fall protection solutions. So choose Gorbel for all your overhead material handling and fall protection, and see for yourself what sets us apart.

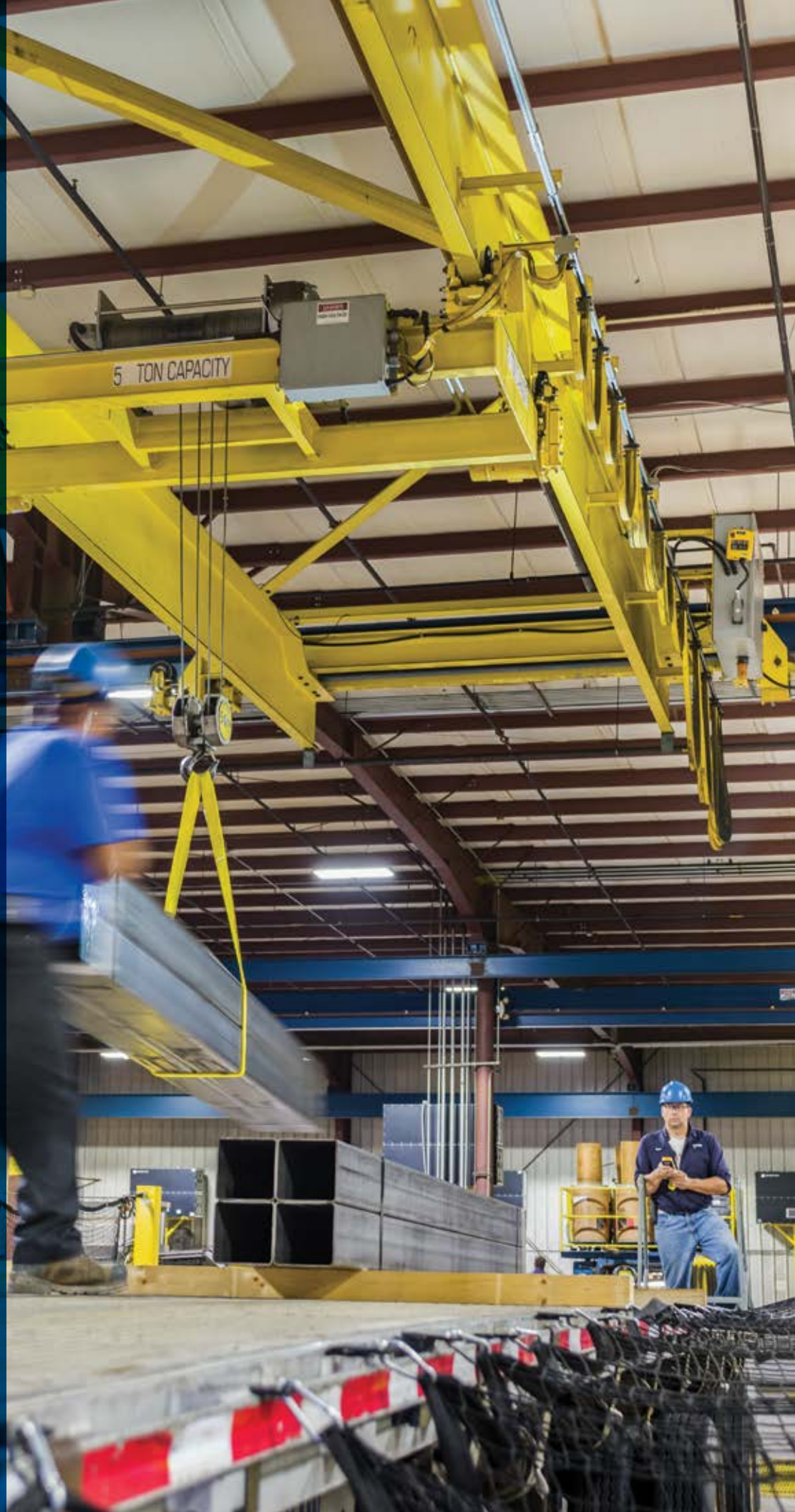

MMA Monorail
Manufacturers
Association
Workstation Cranes and
Patented Track Systems

Aim higher with Gorbel overhead material handling and fall protection solutions.

Whether you're moving materials or protecting workers at heights, the owners of overhead safety have your back. Gorbel cranes, ergonomic lifting solutions and fall protection devices can be found in virtually every industrial environment, elevating safety, productivity and profitability.



Cranes

Offering a complete range of coverage options, our Work Station and Jib Cranes can be found hard at work anywhere productivity and safety are a priority.

- 4 Enclosed Track Work Station Bridge Cranes and Monorails
- 6 I-Beam Jibs
- 8 Enclosed Track Jib Cranes
- 10 Articulating Jib Cranes
- 12 Gantry Cranes
- 13 Cleveland Tramrail®

Ergonomic Lifting

Gorbel Ergonomic Lifting Devices are the perfect complement to your Gorbel crane.

- 16 Ergonomic Lifting Introduction
- 18 GS Series Electric Chain Hoists
- 20 Intelligent Lifting Devices
- 23 Handle Options

Fall Protection

Our Tether Track® Fall Arrest Systems provide a reliable and cost-effective solution for reducing the risk of injury in elevated work environments.

- 24 Fall Protection Introduction
- 25 Bridge Systems
- 26 Free Standing Monorail Systems
- 26 Ceiling Mounted Monorail Systems
- 27 Swing Arm Systems
- 27 Fold Away Systems
- 28 Single Pole Systems
- 28 Portable Gantry Systems
- 29 Track Types, Supports and Hangers
- 30 Road Ranger™ Mobile Anchor
- 31 Ranger™ Mobile Anchor



Get it done with a Gorbel Crane.

Whether you're lifting 50 lbs. or 40 tons, Gorbel Cranes keep you moving. Our Work Station and Jib crane solutions are known the world over for quality and reliability, and our Cleveland Tramrail® Patented Track line continues to be the benchmark by which all other track cranes are measured. So, whatever industry you're in, we've got the crane solution you need to get it done better, faster, safer.

Elevate your applications with our rugged Work Station Cranes.

Available in free standing and ceiling mounted configurations, Gorbel® Work Station Cranes are a proven way to improve productivity, increase quality, and provide a safer work environment. Our aluminum and steel systems feature an enclosed track that is high in strength and low in weight.

With the ability to span up to 30 ft. and lift capacities between 150 and 4,000 lbs., they ensure a higher level of productivity.

- Capacities up to 4,000 lbs.
- Ergonomic design minimizes operator injury
- Steel, aluminum and stainless steel track options
- Increase productivity by 28% or more

FREE STANDING floor-supported work station cranes do not put stress on the building's overhead structure.



MODULAR DESIGN PERMITS EASY EXPANSION AND RELOCATION.



Enclosed Track Work Station Cranes

FREE STANDING BRIDGE CRANES

Free Standing floor supported systems do not put stress on the building's overhead structure. Installation is usually more straightforward, and these cranes are also easier to relocate in the future. Free Standing Systems require a reinforced concrete floor that's at least 6 inches thick.

- Capacities from 150 to 4,000 lbs.
- Rectangular coverage with up to 34' bridge and 124' runway standard
- Standard support distances of 20', 25', and 30'

CEILING MOUNTED BRIDGE CRANES

With Ceiling Mounted Systems, supporting steel does not interfere with the handling operation. Ceiling Mounted Systems require a building with an adequate overhead structure to hang the crane.

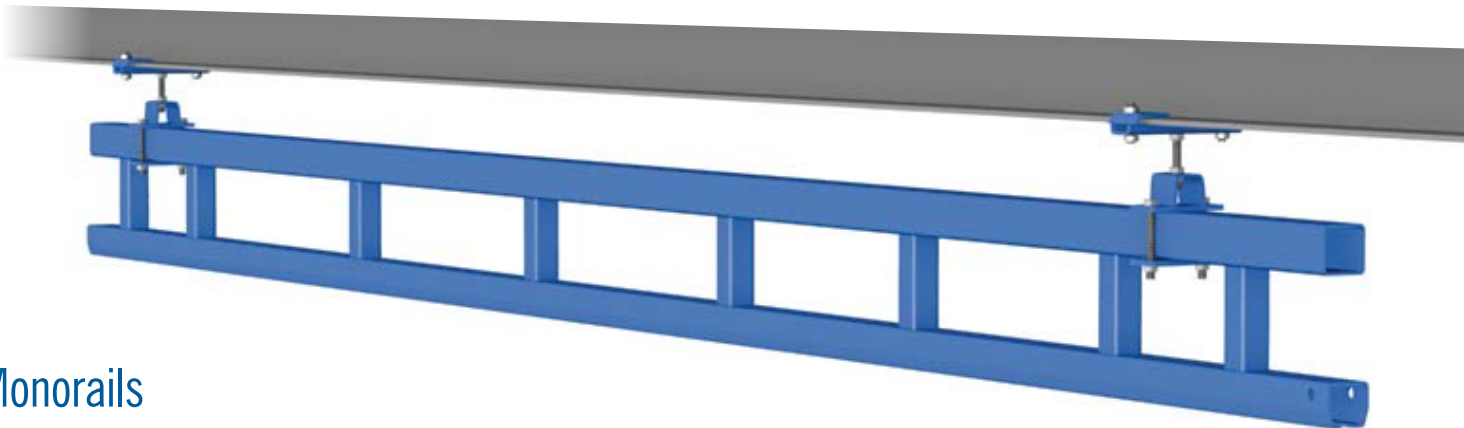

Monorails

With their excellent layout flexibility, our monorails are ideal for production processes that require lifting and moving materials along a fixed path.

- Capacities from 150 to 4,000 lbs.
- Linear movement
- Modular designs provide ultimate flexibility
- Can be integrated into a total system with extra track, curves, interlocks and switches



Heavy-duty I-Beam Jibs, always ready for duty.

From free standing to floor-supported to wall bracket configurations, Gorbel I-Beam Jibs are synonymous with quality, safety and performance. Designed to lift and move materials in semicircles or full circles, they're a cost-effective way to ensure maximum productivity in environments with limited space.

FREE STANDING JIB CRANES

Free Standing Jibs are our most versatile cranes. They're ideal for placement beneath large bridge cranes in open areas where they can serve multiple work stations. Free Standing Jibs are also popular for outdoor applications such as loading docks, or in machining and assembly operations where they can be overlapped with other jibs to provide staged operation.

- Capacities up to 10,000 lbs.
- Circular coverage: standard spans to 20'
- 3 mounting styles—base-plate mounted, sleeve mounted and insert sleeve mounted
- Independent head assembly installs separately for ease of installation
- Full supporting triangular base plate gussets are used instead of struts to minimize crane deflection and make positioning loads easier

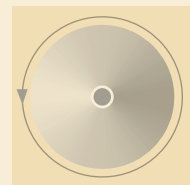

360° Rotation

WALL BRACKET JIB CRANES

Wall Bracket Jib Cranes are the most economical means of providing hoist coverage for individual use in bays, along walls or columns of plants, or as a supplement to an overhead crane or monorail system.

- Capacities up to 10,000 lbs.
- Circular coverage: standard spans to 30'
- 200° rotation
- Single tie rod, right-hand threaded at both ends for easy boom adjustment and installation
- Ideal for swinging around obstacles or under obstructions

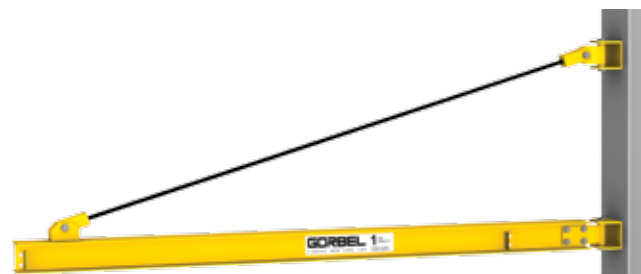

200°
Rotation



WALL CANTILEVER JIB CRANE

The Wall Cantilever Jib Crane provides hoist coverage and 200° rotation for individual use in bays, along walls or columns of plants, or as a supplement to an overhead crane or monorail system. The jib has the advantage of providing maximum lift for the hoist, since it can be installed very close to the underside of the lowest ceiling obstruction.

- Capacities up to 10,000 lbs.
- Circular coverage: standard spans to 20'
- 200° rotation
- Requires a structurally adequate wall or column to mount to
- Welded or bolted connection depending on bracket centers



MAST-TYPE JIB CRANES

This jib crane is floor supported, top stabilized, and is capable of 360° rotation via a top and bottom bearing assembly. The efficient design eliminates the need for a special foundation, making it our most cost-effective 360° rotation jib.

- Capacities up to 10,000 lbs.
- Circular coverage: standard spans to 20'
- 360° rotation
- MT400 Full Cantilever—provides maximum amount of lift where full use of available headroom is desired
- MT450 Drop Cantilever—Jib boom can be placed at a specific height to clear overhead obstructions

Enclosed Track Jib Cranes

FREE STANDING JIB CRANES

Our Free Standing Enclosed Track Jib Cranes can be bolted directly to your existing floor without adding special foundations. Additionally, installation and adjustments are easy with our eccentric cam followers.

- Capacity up to 1,000 lbs.
- Coverage: circular, standard spans to 16'
- 360° rotation
- Designed to support tool balancers, air balancers, vacuum lifters, and hoists

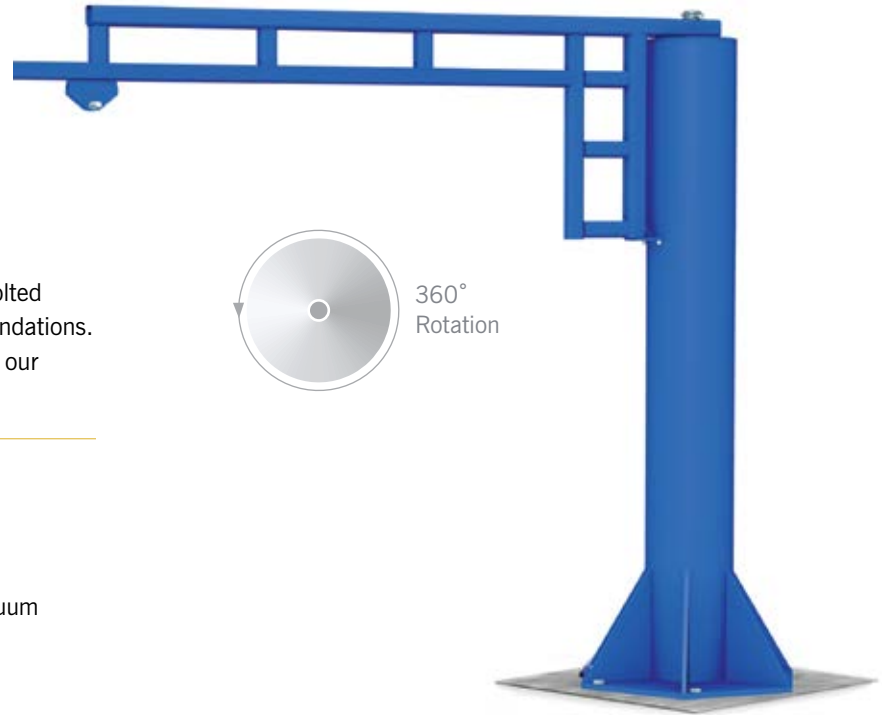

WALL MOUNTED WORK STATION JIB CRANES

Our Wall Mounted Work Station Jib Cranes use tapered roller bearings at the pivot points for unsurpassed ease of rotation. The cantilevered design allows for maximum headroom.

- Capacities up to 1,000 lbs.
- Circular coverage: standard spans to 20'
- 200° rotation
- Can be mounted to a wall or column

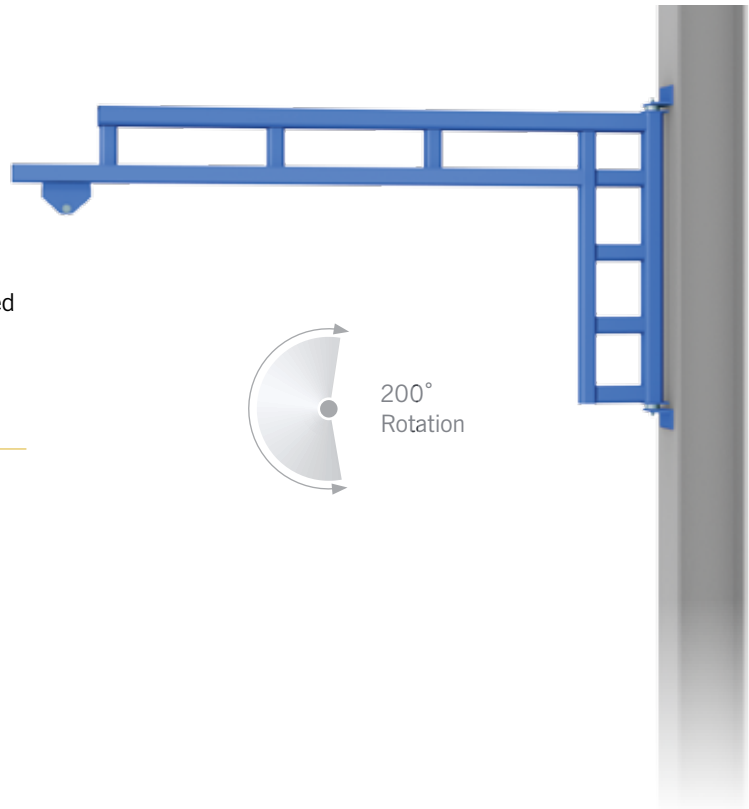
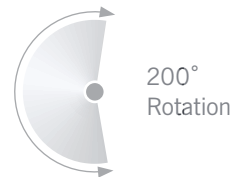

ALUMINUM TIE ROD JIB CRANES

These cranes utilize our patented lightweight, high-strength extruded aluminum enclosed track for the boom. This revolutionary track reduces the rotational dead weight of the boom by 56% to 68%, and allows 40% more rotation than a traditional I-beam jib.

- Capacities up to 2,000 lbs.
- Circular Coverage: standard spans to 20'
- 200° rotation
- Made of lightweight aluminum enclosed track
- Tie rod minimizes deflection for more precise positioning



FREE STANDING TOOL SOLUTION JIB CRANES

Our Tool Solution Jib Cranes are a durable, lightweight option for applications with suspended tooling or light-duty lifting. Their small footprint makes installation possible in small areas, such as between machines.

WALL MOUNTED TOOL SOLUTION JIB CRANES

With a slim profile and simple installation, Wall Mounted Tool Solution Jib Cranes excel in tight work spaces. The small bracket centers make it ideal for low-headroom applications.

- Capacities of 50 lbs. and 150 lbs.
- Circular coverage:
 - 50 lb. standard spans from 4' to 10'
 - 150 lb. standard spans from 4' to 12'
- Free Standing standard heights from 8' to 10'
- Designed to be smaller, lighter and more cost effective for applications with suspended tools

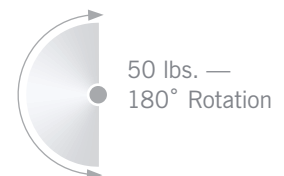
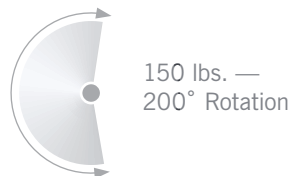

Articulating Jib Cranes

FREE STANDING ARTICULATING JIB CRANES

The Free Standing Articulating Jib Crane is perfect for environments that would greatly benefit from an articulating jib, but lack the necessary walls or columns to mount the crane. This crane offers effortless rotation and a consistent responsiveness when positioning loads in a work cell, through open doorways, or into machines.

- Capacities up to 2,000 lbs.
- Circular coverage: standard spans to 16'
- 360° rotation at each pivot point
- Can be used with hook mounted lifting devices (electric, air, or vacuum)

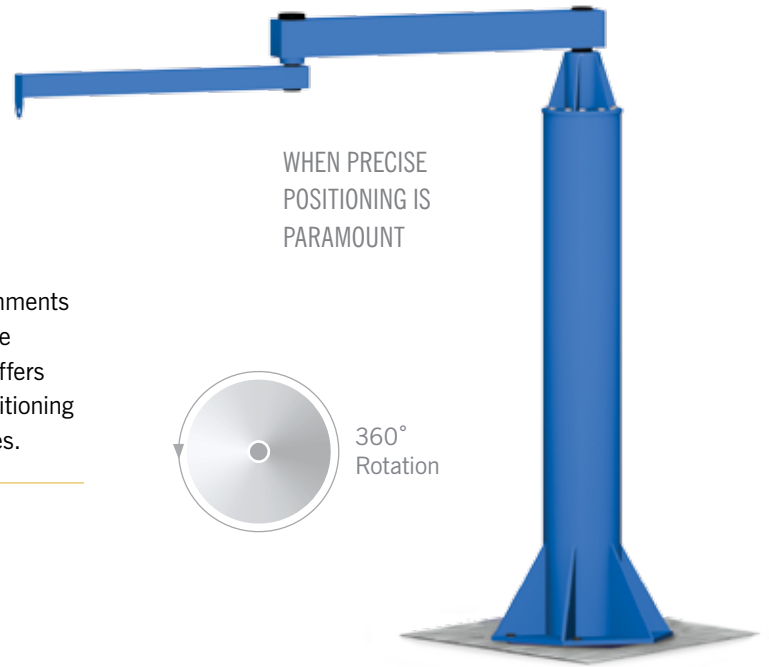

CEILING MOUNTED ARTICULATING JIB CRANES

Ceiling Mounted Articulating Jib Cranes can be stationary mounted or platform supported from a Gorbels® Work Station Dual Girder Bridge Crane, which enables usage outside the normal coverage of a bridge crane or the jib to swing under obstructions. With the jib mounted to a platform, multiple work cells can be covered with just one crane and lifting device.



WALL MOUNTED ARTICULATING JIB CRANES

The Wall Mounted Articulating Jib Crane is perfect for applications that require maneuvering around or under obstructions and where there is an adequate wall/column to support the crane.

- Capacity up to 2,000 lbs.
- Circular coverage: standard spans to 16'
- 200° rotation at the primary boom

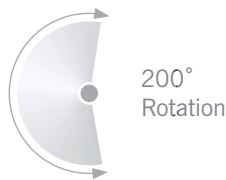

WALL MOUNTED PIVOT PRO®

The Wall Mounted PIVOT PRO can help you position loads in places you couldn't reach with traditional jibs. It provides easy rotation and consistent responsiveness when positioning loads throughout the crane's coverage area. It is capable of 200° rotation on the primary arm and 300° rotation with the secondary arm.

- Capacities up to 150 lbs.
- Circular coverage: standard spans to 12'
- 200° rotation on primary boom and 300° on secondary arm



FREE STANDING PIVOT PRO®

Great for vacuum lifting applications or lighter-capacity applications where an articulated arm would be beneficial. For vacuum lifting, the PIVOT PRO features vacuum-sealed arms to reduce hose festooning.

- Capacities up to 150 lbs.
- Circular coverage: standard spans to 12'
- Standard heights under boom to 12'
- 360° rotation on primary boom and 300° on secondary arm

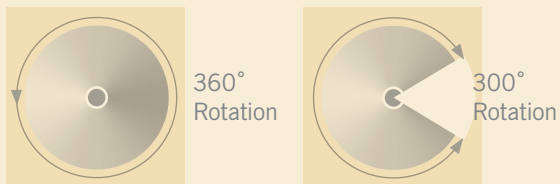

Gantry Cranes

FIXED AND ADJUSTABLE HEIGHT GANTRY CRANES

Steel Gantry Cranes provide an economical way to lift materials anywhere within a facility. The casters enable you to move the gantry around your work area. This is a more cost-effective lifting solution for areas of infrequent lifts than a more expensive permanent structure. Our heavy-duty end frame design with square tubing uprights, knee braces and channel base provides stable lifting and movement.

- Capacities up to 5 tons
- Spans from 8' to 30'
- Easily moved to any location in a facility
- Cost effective for areas with infrequent lifts

FIXED HEIGHT

- Heights from 10' to 20'

ADJUSTABLE HEIGHT

- HUB heights range from 7' (min.) to 20' (max.)

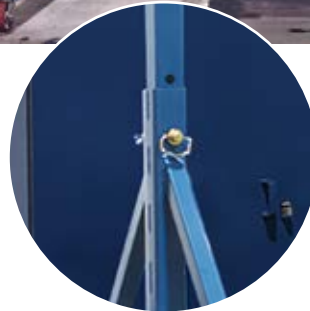

Adjustable Height Gantry: adjustable in 6" increments to provide different lifting heights.



ADJUSTABLE HEIGHT ALUMINUM GANTRY CRANES

Made from lightweight extruded materials, the components of the Adjustable Height Aluminum Gantry Crane are easily lifted by one person. This provides cost-effective shipment to a job site, and allows for ease of use in a multitude of work areas—for example, carrying material up a ladder or staircase to a rooftop work area.

- Capacities from 1000 lbs. to 4000 lbs.
- Standard spans up to 20'.
- Height under boom 6' to 12'
- Adjustable in 6" increments to provide different lifting heights
- Collapsible for easy storage

CLEVELAND  TRAMRAIL
By Gorbel Inc.

UP TO **40** TON
CAPACITY





Cleveland Tramrail®

Cleveland Tramrail® Patented Track Cranes are the gold standard of overhead cranes. We've built a reputation based on quality products, top-notch service, engineering expertise, and application knowledge. This combination allows us to provide flexible integrated solutions that will give your productivity a lift.

Cleveland Tramrail's unique Tarca Track, with its special raised tread and high-carbon track, is superior to I-beams in strength, durability, and consistency. Our rails permit the use of underhung carriers operating on a single straight, curved, or inclined track or operating on two or more straight track runways.

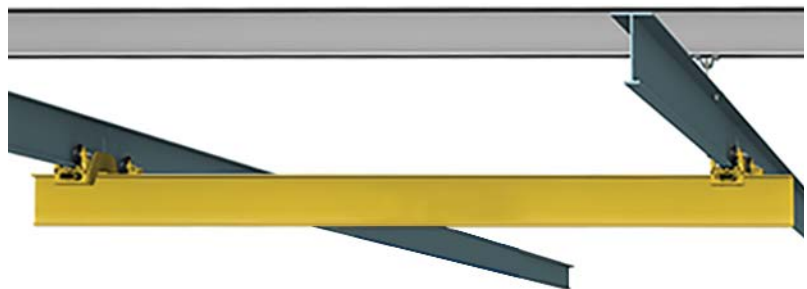

CLEVELAND TRAMRAIL UNDERHUNG SYSTEM

Our patented underhung crane systems have an impressive track record of reliable, long-lasting service in high-duty-cycle applications, loading docks, parts assembly, equipment maintenance and truck service centers.

- Capacities from 5 to 40 tons
- Rectangular coverage with spans to 38'
- Support centers up to 50'
- Easily changeable and expandable

CLEVELAND TRAMRAIL MONORAILS

Superior to I-beams in strength, durability and consistency, Cleveland Tramrail Monorails are ideal for applications that require the movement of materials throughout an entire production area.

- Capacities from 5 to 40 tons
- Straight and/or curved path routes
- Can move materials through entire production area
- Easily changeable and expandable

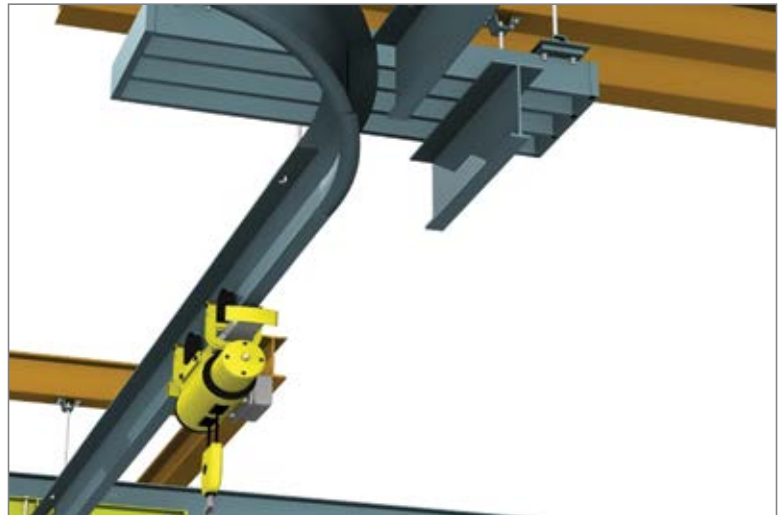

FREE STANDING TARCA® SYSTEM

With consistently straight rail sections and durable components that ensure long, productive service life, our Free Standing Tarca Track System sets the standard for the rest of the industry.

- Capacities up to 5 tons
- Completely free standing or braced systems
- Rectangular coverage with spans to 60'
- Runway supports centers available in 20' to 40' increments

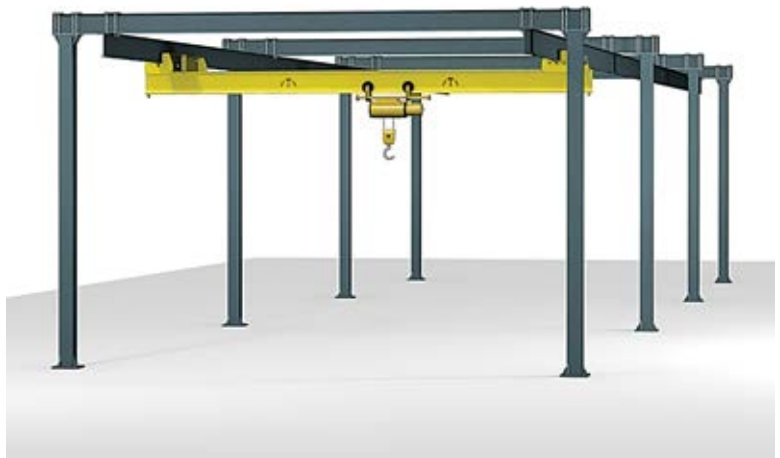

CEILING MOUNTED TARCA® SYSTEM

Our Ceiling Mounted system is ideal for applications where maximum headroom is required.

- Capacities up to 5 tons
- Rectangular coverage with spans to 58'
- Custom support centers up to 50' on runways



Ergonomic solutions for an easier lift.

Material handling has undergone a dramatic transformation, with ergonomic lifting fast becoming the preferred solution over manual lifting. Gobel offers a full range of these solutions, including **ELECTRIC HOISTS** and **INTELLIGENT LIFTING DEVICES (ILDs)**. Both are proven to eliminate repetitive-motion injuries, reduce damage to products and fragile parts, and facilitate increased levels of productivity and profitability.



ELECTRIC HOISTS are a great option for most standard material-handling applications.



ILDs are ideal for those applications that require precision lifting and multiple speeds.



Ideal for high-production
and periodic lifting.

GS Series Electric Chain Hoists

Available in a wide variety of models and configurations, our rugged line of GS hoists is ideal for just about every application—from high-production environments to settings that require only periodic lifting and positioning. Their compact design makes them a good fit for all types of spaces, including those with low headroom, and they're easy to install, maneuver and relocate. Other benefits:

- All components, including gears and case, are fabricated in a single location to ensure superior quality control
- Available in a variety of three-phase configurations, as well as 111-1-60
- Capacities from 1/8 to 5 tons meet the needs of users in a wide range of applications
- Compatible with Gorbel® Work Station Crane trolleys or equipped with trolleys for S and W beams
- User-friendly direct-acting upper and lower switches may be set in a matter of seconds
- Tested in accordance with ASME and FEM/ISO

Quality components that elevate our GS line and your applications.



PENDANT HANDLE

Ergonomic control pendant requires low operator force and is equipped complete with E-stop.



SINGLE- AND DOUBLE-FALL CONFIGURATIONS

Our hoists are available in single- and double-fall configurations to meet a wide range of headroom, lifting speed, and capacity requirements.

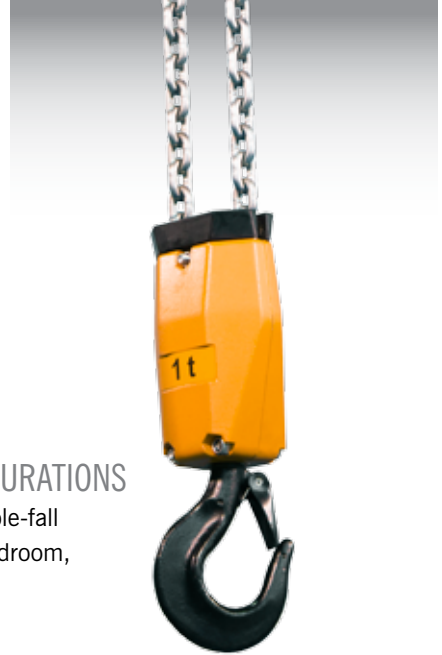

LIMIT SWITCH

Modular upper and lower limit switches designed for durable operation.



CHAIN CONTAINER

A canvas chain bag comes standard with all Gorbel hoists. Prefer a more conventional style? Select the optional plastic bucket, a sturdy but lightweight option that doesn't dent or rust like metal chain containers.



SINGLE- AND DOUBLE-HOLE, AND UPPER HOOK SUSPENSION PLATES

Our single- and double-hole suspension plates are the perfect option when headroom is an issue. Upper hook suspensions are available in both rigid and swivel styles.



Intelligent Lifting Devices take your productivity to the next level.

Combining the agility and responsiveness of a human operator with the power of a machine, Intelligent Lifting Devices (ILDs) are revolutionizing the material-handling landscape.

Gorbel's line of ILDs is leading the transformation with systems that can make repetitive-motion injuries obsolete, eliminate product damage, and facilitate record-breaking levels of productivity.

WHAT SETS ILDs APART:

Easy operator interface

High-speed electric servo-controlled drive system

Integration with process and control systems

Combination of blazing speeds and pinpoint precision in one device

Patented Float Mode for more precise control

Intelligence-enhanced safety features

G-Force® Intelligent Lifting Devices

There are two models of Gorbel Intelligent Lifting Devices to choose from: the Q and the iQ. While they look the same on the outside, it's a whole different story when you look under the hood:

G-FORCE Q MODEL

Our standard, feature-packed model delivers all of the speed and precision of our high-end iQ, but without the Input/Output features.

G-FORCE iQ MODEL

G-Force iQ offers a slew of additional "intelligence" features, including teachable virtual limits and speed reduction points.



G-FORCE BENEFITS:

- Capacities from 165 to 1320 lbs.
- Speeds up to 200 ft. per minute
- Can cover multiple work cells
- Rapid return on investment through increased productivity and reduced product damage
- Decreases risk of operator injury, creating a safer work environment
- Higher environmental ratings (more tolerant to dust and liquid)
- Enhances job performance



G-FORCE FEATURES:

- Anti-Recoil Technology prevents sudden movements and recoil
- Infinite Speed Control for applications that require multiple speeds in a cycle
- Power Loss Protection locks the unit in place in case of power loss
- Pinpoint Precision gives operator the ability to finesse expensive or fragile parts
- Float Mode allows operators to precisely orient loads using just 1/2 lb. of pressure

Easy Arm® Intelligent Assist Devices

The Easy Arm® Intelligent Lifting Arm is ideal if you're looking for a turnkey, plug and play lifting solution. You get all the strength, precision, and speed of our patented G-Force superior lifting technology and processor-controlled electric servo-drive system in the body of an ergonomic articulating jib crane.

As with G-Force®, there are two Easy Arm® models to choose from: the Q and the iQ.

- Capacities: 165 lbs., 330 lbs., 660 lbs.
- Spans from 6' to 14'
- Height under hook of 6' to 11'
- Speeds up to 180' per minute
- 660 lbs., with lifting speeds up to 45' per minute in high-production environments
- Cost-effective turnkey solution



UNDERHUNG EASY ARM

A cost-effective turnkey solution for reaching under overhead obstructions or into work cells or machinery.

- Capacity up to 165 lbs.
- Frees up valuable floor space
- Mounts to an existing bridge crane
- Two pivot points allow it to reach around obstacles or into machinery

ILD Control Handle Options

The G-Force® and Easy Arm™ were designed to provide flexibility in handle configurations. Choose from the following configurations to best fit your application.



PENDANT HANDLES

This two-button infinitely variable control handle can be used with G-Force® and Easy Arm. It is a no-charge optional alternative to our standard G-Force slide handle. The Pendant Control buttons require less than one pound of force to depress, making it up to 70% easier than traditional pendants. This reduces the potential for fatigue and repetitive stress injuries of the hand and wrist.



FORCE SENSING HANDLES

Our Force Sensing Handles offer true versatility in ergonomic lifting. Compared to standard slide handles, which use displacement of the handle to initiate upward or downward motion, these devices sense force applied without any handle motion. This creates a versatile option for tooling, or elongated handles that perfectly serve applications with a wide range of motion.



SLIDE HANDLES

The in-line slide handle allows the operator to get close to the load for more control and precision. The remote mount slide handle offers the same smooth control as the slide handle, but accommodates set-ups where the operators can't be close to the load.



G 360™ SWIVEL ASSEMBLY

Our G-Force® Intelligent Lifting Devices have a combined collector/air swivel that allows the handle to continuously rotate without damaging electrical conductors in the coil cord or optional air coil. This is ideal in applications where the operator is continuously rotating the handle.

Tether Track[®] Fall Protection

Everyone's safety hangs in the balance.

The facts are alarming. According to data compiled by the Bureau of Labor Statistics, each year hundreds of workers are killed and thousands are seriously injured by preventable workplace falls. In addition to the tragic human toll, these accidents cost businesses billions each year in medical bills, lost productivity, fines and lawsuits. Now, regulatory agencies are tightening their requirements for fall protection even more, and increasing penalties and fines for noncompliance.

THE OSHA FOUR-FEET RULE

Under Title 29 of the Code of Federal Regulations (29 CFR), the Occupational Safety and Health Administration (OSHA) requires fall protection at elevations of four feet or more.



4'

General
Industry





ANCHOR YOUR FALL PROTECTION PROGRAM WITH TETHER TRACK®

Using a Gorbel Tether Track Rigid Rail Fall Arrest System as your anchor provides workers with a high degree of mobility and freedom, while preventing falls to lower levels. Standard systems are designed to accommodate multiple workers, each weighing up to 310 pounds with tools.

Gorbel Tether Track Rigid Rail Fall Arrest Systems provide a reliable and cost-effective solution for reducing the risk of injury in elevated work environments. Available in various configurations.

Download our Anchorage Assessment to determine your fall arrest risk level at www.Gorbel.com/RightTrack

Tether Track® Bridge Systems

CEILING MOUNTED SYSTEMS use the structure for support, as the rail is mounted either perpendicular or parallel to the ceiling beams. Should overhead obstacles be present, drop rod hangers with sway bracing can be supplied so that the system avoids these obstructions.

FREE STANDING SYSTEMS may be preferred whenever floor space is readily available to install column supports, when changes in work practices are anticipated, and when a building structure isn't available. The flexibility of free standing systems allows them to be easily modified and moved should processes or fall protection needs change.

Multiple bridges can be supplied for both ceiling mounted and free standing systems, thus allowing multiple workers to utilize the system simultaneously.

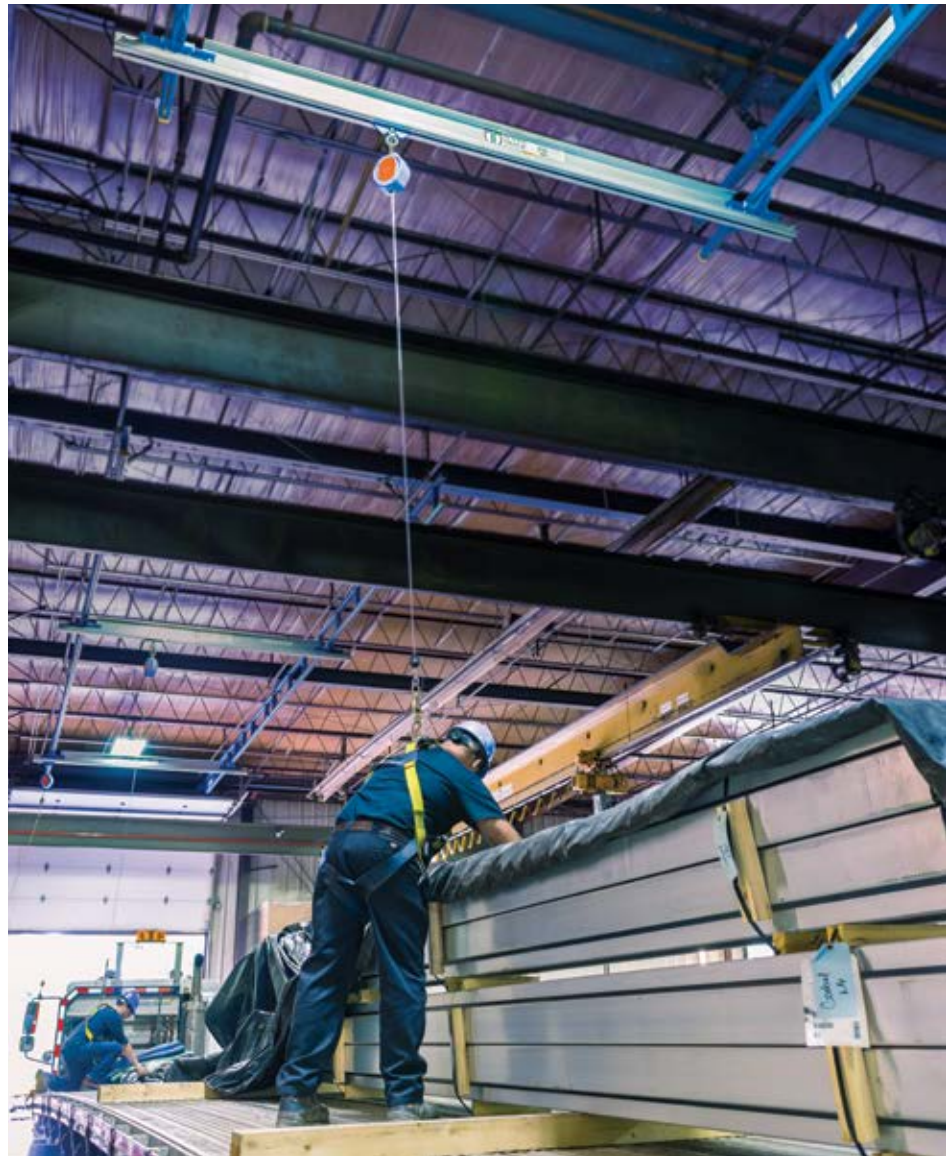

Monorail Systems

FREE STANDING

Engineered for areas that require long spans and an independent structure for support, this system provides a single path of fall protection in a permanent manner. Numerous configurations are available, including cantilever designs offering economical options and long span capabilities. They are extensively used for outdoor applications and can be treated with special finishes to withstand the elements.



CEILING MOUNTED

When floor space is at a premium, ceiling mounted monorails can provide unparalleled fall protection while maintaining an open floor plan for material handling, production, or related activities. Ceiling mounted monorails mount to existing support steel and are ideal for production facilities and warehouses with tall ceilings or floor obstructions. Even if the facility has standard ceiling heights, the compact, low-profile design of ceiling mounted monorails provides full protection without headroom concerns.





Swing Arm Systems

Designed to accommodate single or multiple workers, our Swing Arm System's dual bypassing track enables workers to safely pass one another without disconnecting. These systems are used extensively in areas where both overhead cranes and fall protection systems share the same space, and can be mounted to an existing wall column or the floor in a free-standing configuration.

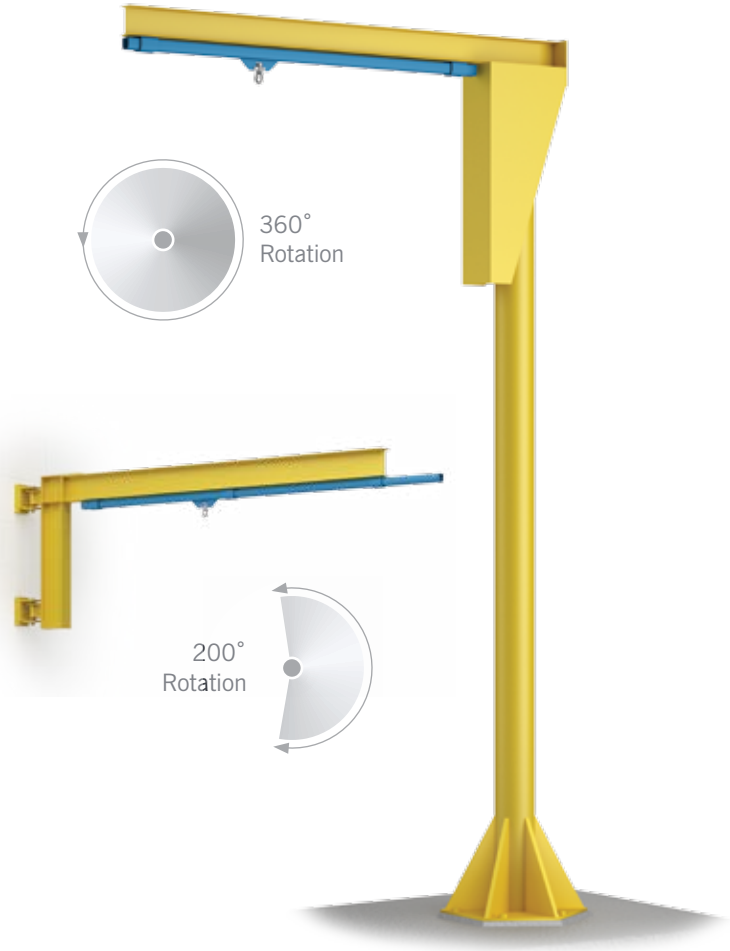

Fold Away Systems

Gorbel's Fold Away Systems provide safety when you need it, and space when you don't. Similar to the Swing Arm Systems, these systems supply convenient fall arrest when extended without sacrificing productivity.

Ideal for areas such as railroad maintenance facilities or where large food processors must be regularly maintained, these systems may be easily moved from the work environment when fall protection is not essential.

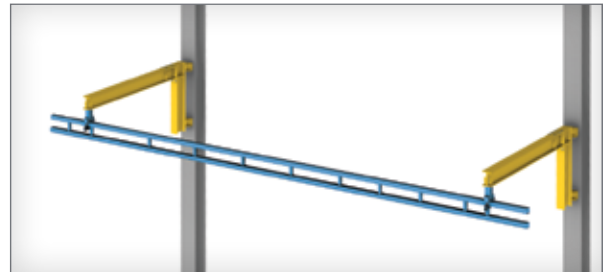

Fully-deployed system

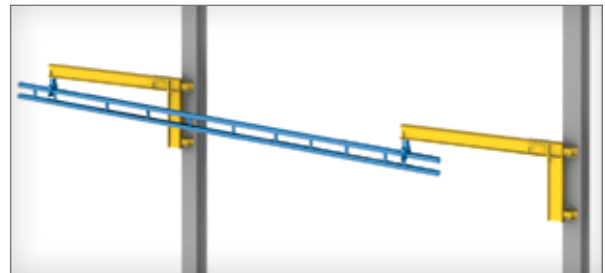

Folds away when not in use



Single Pole Systems

When numerous obstacles exist in the work space and standard multiple-column systems are not practical, single pole systems provide a convenient alternative. Used regularly in tank car servicing or heavy-duty truck securing and tarping areas, single pole systems require only a single foundation. Standard span lengths from 10' to 53' mean the system can be designed to meet the requirements of most loading/unloading and maintenance facilities.

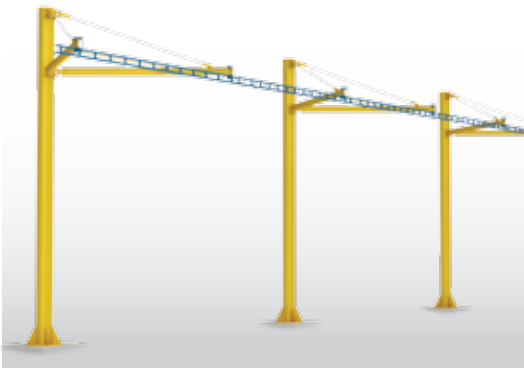

The linked single-pole configuration allows spanning greater distances between supports.



Portable Gantry Systems

The Tether Track portable fall arrest gantry is ideal for applications where a permanent solution is not possible. It allows for single or multiple users to complete their required tasks, and can then be moved out of the way when not needed. The square tubing uprights, knee braces, and channel base allow for stable movement, while the Tether Track trolley rolls smoothly on an enclosed track flush mounted beneath the beam.



- Available at fixed heights up to 20' hook height and spans up to 20'
- Adjustable heights available as an option
- Multiple areas can be serviced with a single, portable unit
- Different caster options available dependent on the environment
- Casters include cam breaks and swivel locks to keep gantry from moving



Tether Track® Enclosed Tracks

The building block for Gorbel's rigid anchor system is our enclosed track design, which is engineered for easy movement. The cold-rolled steel track keeps dirt and dust from settling on the rolling surface, allowing for smoother, more consistent ease of movement than an I-beam with no need for cleaning or maintenance of the track.

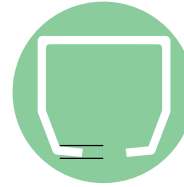

2° taper keeps the trolley centered



PLAIN TRACK

Plain enclosed steel track provides smooth motion with the benefit of offering the most headroom of any track style.

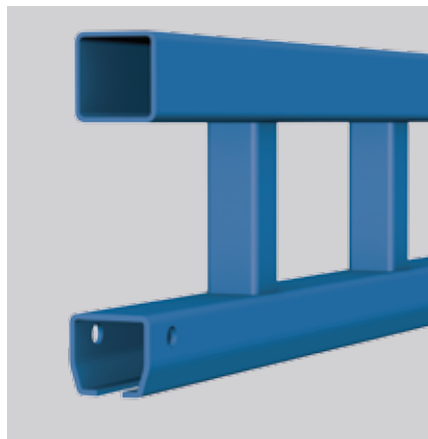

TRUSSED TRACK

Single trussed track allows for the longest possible spans between supports, reducing hardware and installation costs.



DUAL TRUSSED TRACK

The dual track enables one worker to pass by another on a monorail system without unsafely disconnecting.



Recover Trolley

The Recover Trolley locks in place when a fall occurs to increase the possibility of the worker regaining composure and reaching the work surface for an efficient recovery from a fall.

- Low rolling resistance
- May reduce suspension trauma
- May provide additional rescue options when self-recovery does not occur



Road Ranger™ — The only mobile anchor rated for highway towing.

The new Road Ranger Mobile Anchor systems delivers all the benefits of the traditional Ranger, with one key difference: it's rated for highway travel. Ideal for use when maintaining aircraft, railroad cars, industrial equipment or heavy machinery, the Road Ranger's sleek, balanced design allows for easy towing and transport to and around the job site.

The system's adjustable-height 2-inch ball coupler attaches easily to trucks and other towing devices. All components are easily accessible at ground level for quick adjustment.

- Rated for highway towing up to 65 mph
- Easy to position with mast folded or fully deployed
- Fully extends to 18', 20', or 22'
- Allows single user to move freely within a 30° work angle in all directions
- Rugged steel construction for superior strength
- Resilient finish for harsh environments



FALL ARREST THAT'S RUGGED,
RELIABLE AND ROAD READY.





Ranger™ Mobile Anchor

Arrest falls anywhere with the new Ranger Mobile Anchor system. The latest offering in our Tether Track line, it's ideal for maintaining and repairing aircraft, industrial equipment or heavy machinery, or for any elevated application that demands mobility. Ranger is designed for quick attachment to forklifts, trucks and other towing devices. Simply move it into place and quickly position it for the work being performed.

All Ranger components are easily accessible at ground level for quick adjustments, and the mast extends in a single plane for precise placement. The D-ring provides a convenient attachment point for self-retracting lanyards, which are used in conjunction with a full-body harness for a complete fall arrest system.

A COMPLETE FALL ARREST SYSTEM THAT'S GOOD TO GO. ANYWHERE. ANYTIME.

- Adjustable to 18', 20', and 22' heights
- Allows single workers to move freely within a 30° work area in all directions
- Battery powered with electromechanical actuator for smooth raising and lowering
- Maximum towing speed of 25 mph

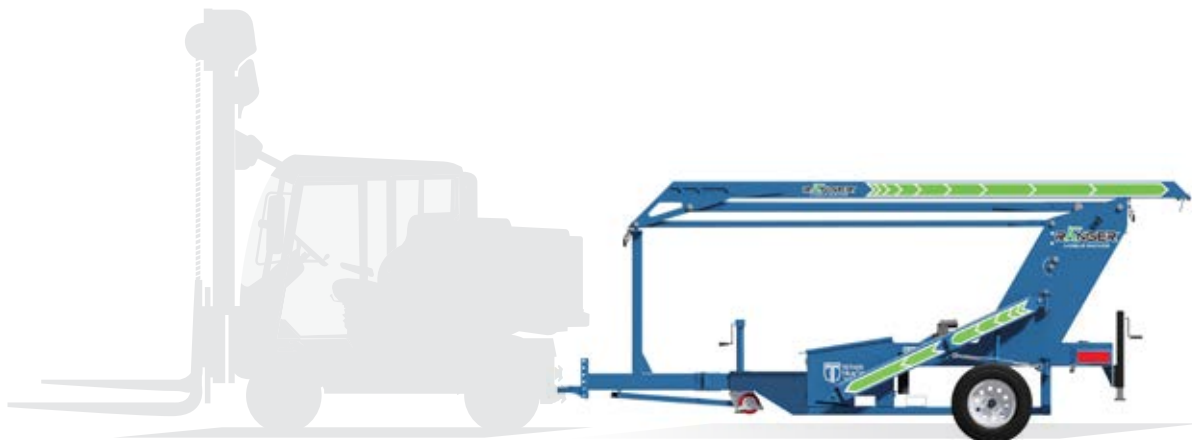

FOR MORE INFORMATION

Your authorized Gorbel® dealer can give you more information on what makes Gorbel's Ergonomic Work Station Cranes and other material-handling products "A Class Above."

BRIDGE CRANES



WORK STATION BRIDGE CRANES AND MONORAILS

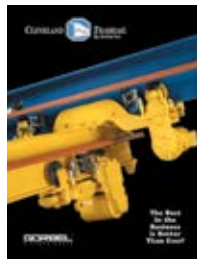

CLEVELAND TRAMRAIL®



WORK STATION CRANE ERGONOMIC STUDY

JIB CRANES

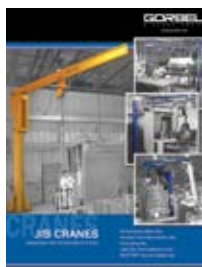

JIB CRANES

ERGONOMIC LIFTING



THE ROI OF ILDs EBOOK



G-FORCE®/EASY ARM®



ERGONOMIC LIFTING STUDY

FALL PROTECTION RESOURCES

The organizations below can supply complete details regarding fall protection requirements. Much of the information is provided free of charge, while some documents are available only for purchase:

OSHA

Occupational Safety and Health Administration
osha.gov
 800-321-6742

ANSI

American National Standards Institute
ansi.org
 212-642-4980

CSA Group

csagroup.org
 800-463-6727

To access Gorbel's FALL PROTECTION TOOLKIT, FALL PROTECTION PLANNING RESOURCE, and FALL ARREST EBOOK, visit www.gorbel.com/righttrack.



GORBEL®
 A C L A S S A B O V E

www.gorbel.com

GORBEL
 600 Fishers Run
 PO Box 593
 Fishers, NY 14453 USA

T 800.821.0086
 T 585.924.6262
 F 585.924.6273
 E info@gorbel.com